

ILC7280

Micropower Dual 150mA CMOS RF LDO™ Regulators

Features

- Low Power Consumption
- 150mV Dropout at 150mA
- 1% Output Voltage Accuracy
- Requires only 0.47µF Output Capacitor
- Only 135µA Ground Current at 150mA load
- 50µV_{RMS} Noise at BW = 300Hz to 50kHz
- Excellent Line and Load Transient Response
- Over Current/Over Temperature Protection
- 8-pin MSOP package
- Voltage Options Available: 3.3/3.3V, 3.0/3.0V, 3.0/2.8V, 3.0/2.5V, 2.8/2.8V, 2.85/2.85V. Other Custom Values available upon request.
- Minimum External Components

General Description

The ILC7280 is two independent 150mA low dropout (LDO)voltage regulators in an 8-pin MSOP package. Each regulator output is independently short circuit protected and has independent enable lines. The device offers a unique combination of low dropout voltage and low quiescent current offered by CMOS technology as well as the low noise and good ripple rejection characteristics of bipolar LDO regulators.

The ILC7280 is available in a space saving MSOP-8 package.

Applications

- Cellular Phones, pagers and wireless headsets
- Palmtops, organizers, PDAs and portable electronics
- Battery powered portable appliances and equipment
- Remote data accumulation and instrumentation

Block Diagram

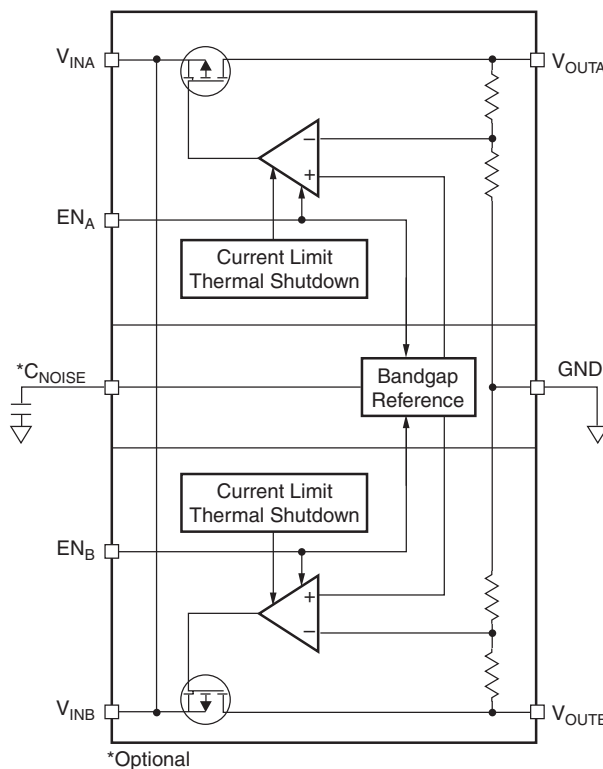

Pin Configuration

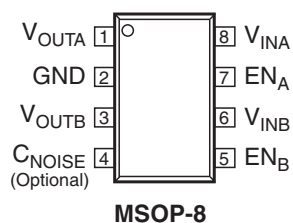

Pin Definitions

Pin Number	Pin Name	Pin Function Description
1	V _{OUTA}	Output A.Regulated voltage
2	GND	Ground of the IC
3	V _{OUTB}	Output B.Regulated voltage
4	C _{NOISE}	Optional bypass for noise reduction.
5	EN _A	Digital Input Enable for regulator A
6	V _{INB}	Supply input B.Internally connected to pin 8*
7	EN _B	Digital Input Enable for regulator B
8	V _{INA}	Supply input B.Internally connected to pin 6*

*If maximum current is required from each regulator, then connect both pin 6 and 8 to power supply.

Absolute Maximum Ratings

Absolute maximum ratings are the values beyond which the device may be damaged or have its useful life impaired. Functional operation under these conditions is not implied.

Parameter	Min.	Max.	Units
Supply Voltage: V _{INA} or V _{INB} to GND		10	V
Voltage on all other pin to GND	-0.3	V _{IN} + 0.3	V
Junction Temperature	-65	150	°C
Storage Temperature	-65	150	°C
Lead Soldering Temperature, 10 seconds		300	°C
Power Dissipation at 85°C		315	mW

Recommended Operating Conditions

Parameter	Conditions	Min.	Typ.	Max.	Units
Supply Voltage V _{DD}	V _{INA} or V _{INB} to GND	V _{OUT} + V _{DO}	V _{OUT} + 1V	9	V
Output Current	I _{OUT}			150	mA
Ambient Operating Temperature		-40		85	°C

Electrical Specifications

(All values are for each regulator at $V_{IN}=V_{OUTnom}+1V$, $I_{OUT}=1mA$, $C_{OUT}=0.47\mu F$, $C_N=0$, $V_{EN}=2V$ and $T_A = +25^\circ C$ using Test circuit in Figure 1, unless otherwise noted.)

Parameter	Conditions	Min.	Typ.	Max.	Units
Output Voltage		0.99 V_{OUTnom}	V_{OUTnom}	1.01 V_{OUTnom}	V
Dropout Voltage	$I_{OUT} = 10mA$		5.5	7	mV
	$I_{OUT} = 150mA$		155	180	
Line Regulation	$V_{OUT} + 1V \leq V_{IN} \leq V_{OUT} + 2V$		0.2	0.5	%/V
Load Regulation	I_{OUT} : 1mA to 150mA		0.3	0.75	%
Ground Pin Current One Regulator ON	$I_{OUT} = 0mA$		80	105	μA
	$I_{OUT} = 10mA$		85	110	
	$I_{OUT} = 150mA$		95	125	
Ground Pin Current Both Regulators ON	$I_{OUT} = 0mA$		120		μA
	$I_{OUT} = 10mA$		125		
	$I_{OUT} = 150mA$		135		
OFF State Current	$V_{EN} = 0V$		150	220	nA
Enable Input Current	$V_{OUT} = 2V$		4	10	μA
	$V_{OUT} = 0.6$		0.2	0.5	
Shut Down Input Voltage	High = Regulator ON	2			V
	Low = Regulator OFF			0.6	
Output Voltage Noise	$C_{OUT} = 2.2\mu F$, $C_N=1nF$, $I_{OUT} = 10mA$, BW = 300Hz to 50kHz		50		μV_{rms}
Ripple Rejection	$C_{OUT} = 4.7\mu F$, $f = 120Hz$		50		dB
	$C_{OUT} = 4.7\mu F$, $f = 1KHz$		45		
Dynamic Line Regulation	V_{IN} : $V_{OUT} + 1V$ to $V_{OUT} + 2V$ $dV/dt = 1V/\mu S$		20		mV
Dynamic Load Regulation	I_{OUT} : 0 to 150mA $DI/dt = 1A/\mu S$		10		mV

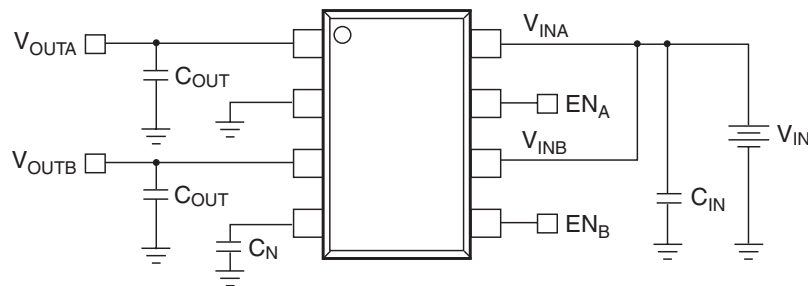
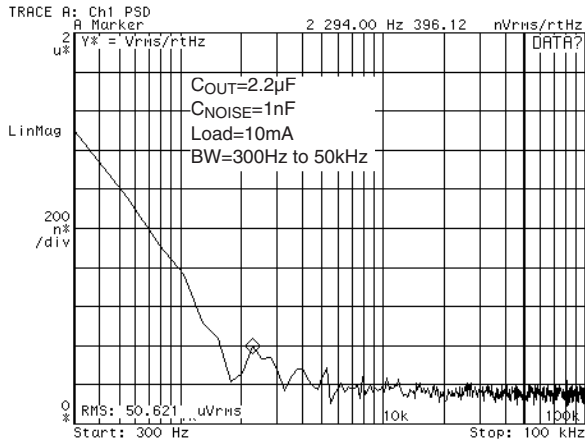

Figure 1. Test Circuit

Typical Applications Diagrams

Power Spectral Density and Output Noise Voltage



Thermal Protection Under Short Circuit Conditions

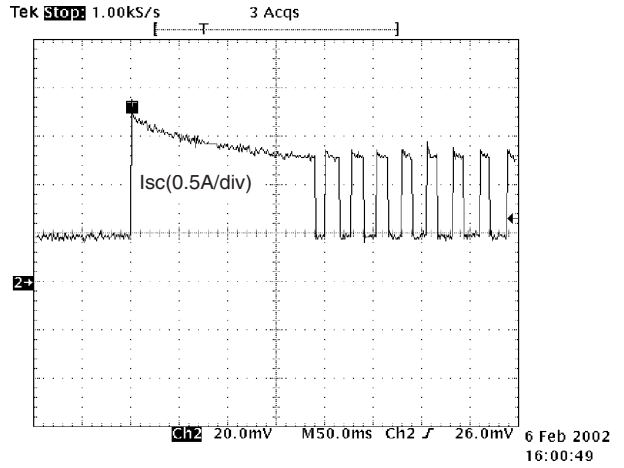

ON/OFF Response, One Regulator ON

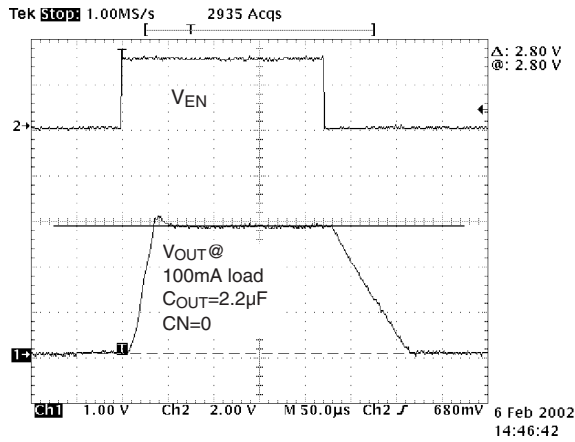

ON/OFF Response, Both Regulators ON

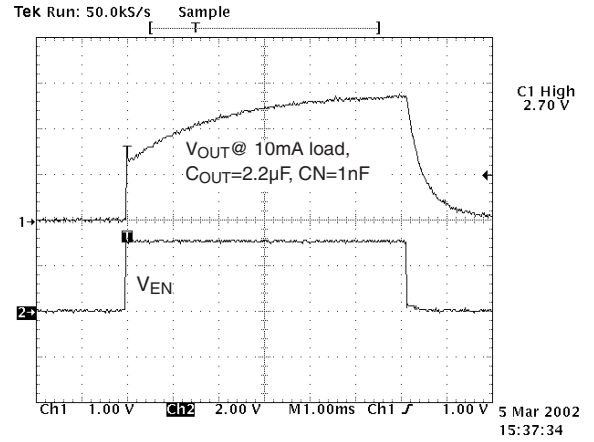

Ripple Rejection, Low Frequencies

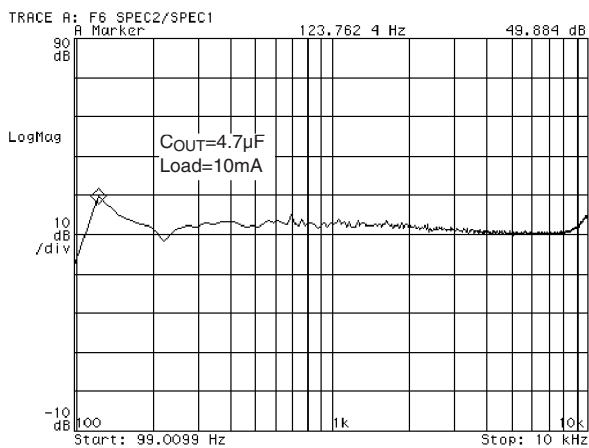

Ripple Rejection, High Frequencies

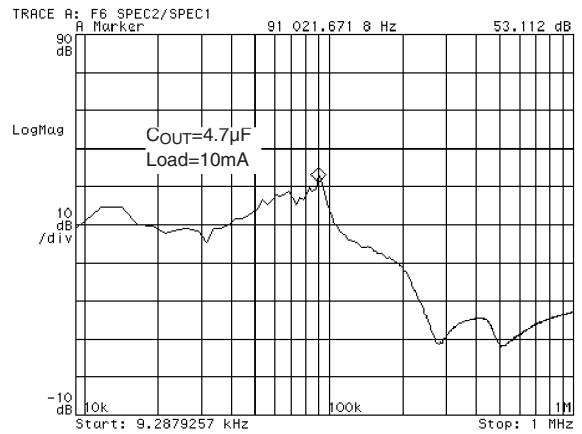

Ripple Rejection, Low Frequencies, 150mA Load

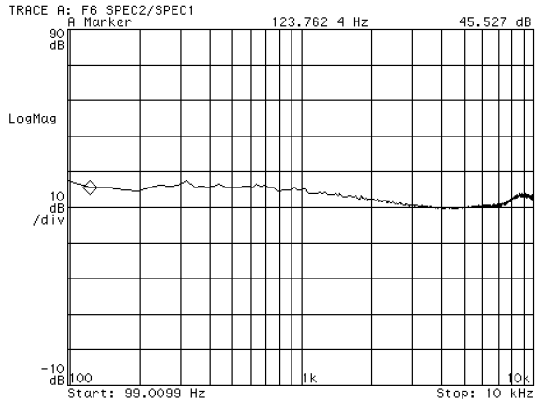

Ripple Rejection, High Frequencies, 150mA Load

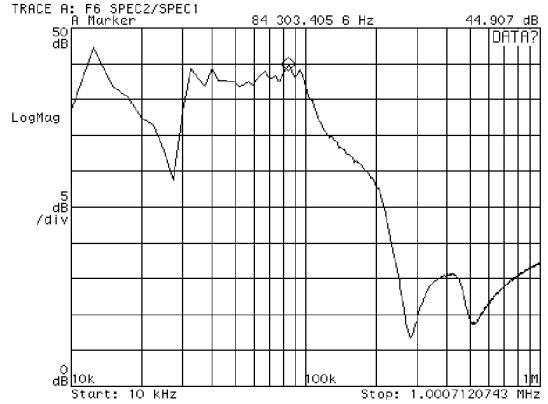

Line Transient Response, 10mA Load

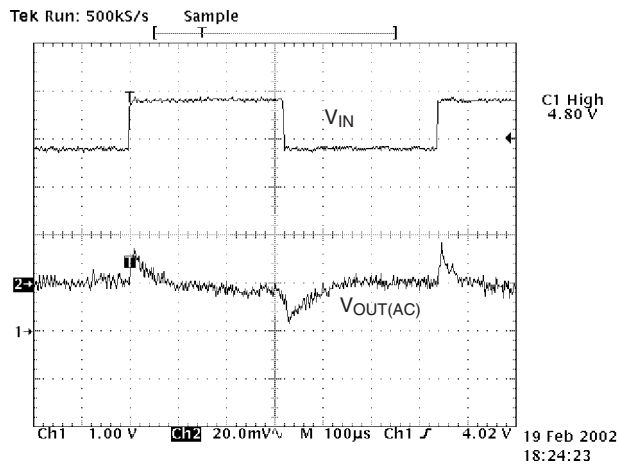

Load Transient Response

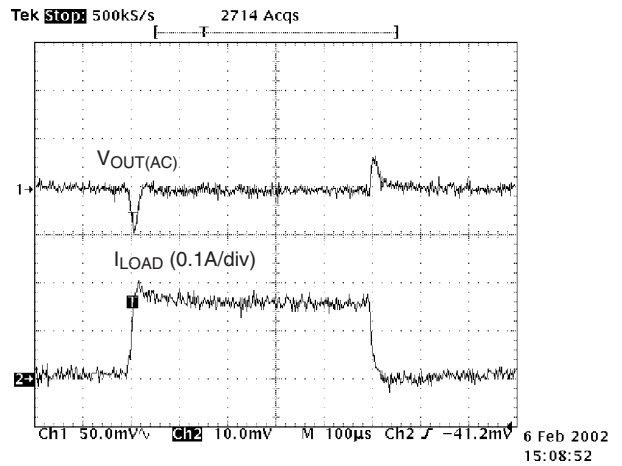

Ground Pin Current, Both Regulators ON

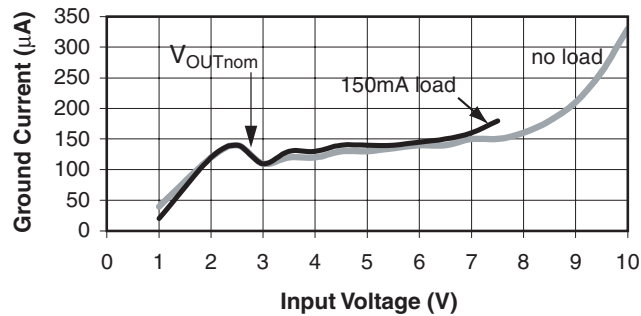

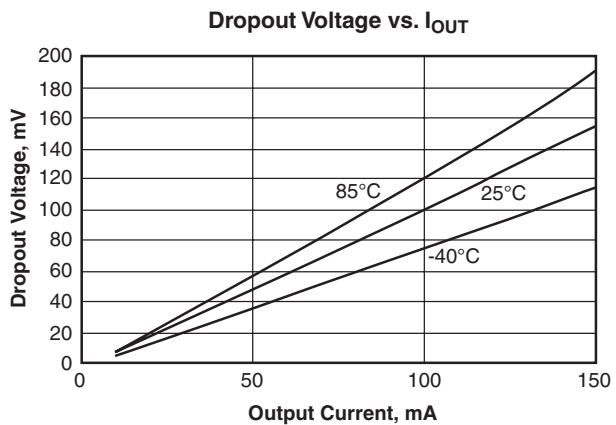
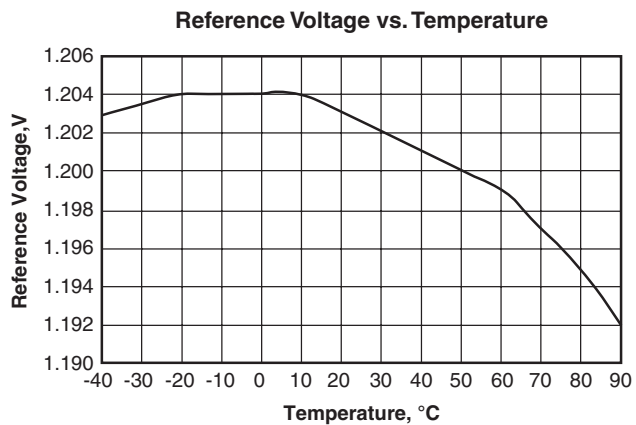

Application Information

V_{IN A and B}

These pins are connected internally through a galvanic connection. For maximum power from each regulator, both V_{INA} and V_{INB} must be connected externally to V₊.

Enable/Shutdown

Forcing EN_A and/or EN_B to a voltage greater than 2V, enables the regulator(s). These inputs are CMOS logic compatible gates. If this feature is not required, connect EN_A and/or EN_B to V_{IN}. Note that V_{INA} and V_{INB} are connected internally. To minimize the effect of imbalanced current sharing and possible noise, both V_{INA} and V_{INB} should also be connected externally.

Input Capacitor

A 1μF capacitor should be placed from V_{INA/B} to GND if there is more than 10 inches of wire between the input and the ac filter capacitor or if a battery is used as the input.

Reference Bypass Capacitor

C_{NOISE} (the reference voltage bypass capacitor) may be connected to the internal V_{REF} which is common to regulator's A and B.

For low noise applications use of 1nF C_{NOISE} is recommended. Value higher than 1nF will lead to minimum improvement of output noise, but it will substantially increase the start-up time. Lower value of C_{NOISE} results in faster start –up. If a slow or delayed start up time is desired, a larger value of C_{NOISE} is used. Conversely, faster start up times or instant-on applications will require smaller values of C_{NOISE} or its omission with the pin left open. The trade-off of noise to response time should be considered.

Output Capacitor

An output capacitor is required from V_{OUTA} and V_{OUTB} to GND to prevent oscillation and minimize the effect of load transient currents. The minimum size of the output capacitor(s) is dependent on the usage of C_{NOISE} and its value. Without C_{NOISE}, a minimum of 0.47μF is recommended. For C_{NOISE} = 1nF, a minimum of 2.2μF is recommended.

Larger values of output capacitance will slightly slow the regulator's response during power up. The ILC7280 remains stable even with ESR values as low as 10mΩ.

If the system design calls for smaller load currents, lower capacitance may be used. Below 10mA the capacitance may be reduced to 0.33μF.

No-load Stability

The ILC7280 will remain stable and in regulation with no load current. These are desirable performance features for applications such as keep-alive modes in CMOS systems.

Split-Supply Operation

When using the ILC7280 in a system requiring that the load be returned to the negative voltage source, the output(s) must be diode clamped to inhibit significant voltage excursions below ground. A simple external diode clamp to ground will protect the device from damage.

Thermal Considerations

In order to minimize thermal resistance (θ_{JA}), the device mounted on conventional FR4 PCB material should be surrounded as much ground copper ground plane as possible. In a worst case application with minimum trace widths and no ground plane, the MSOP-8 package exhibits a thermal resistance of 200 °C/W. The maximum allowable power dissipation is calculated in the following examples.

Thermal Evaluation Examples

The maximum allowed package power dissipation is:

$P_{D(max)} = (T_{Jmax} - T_A) / \theta_{JA}$, where T_{Jmax} is the maximum junction temperature and T_A is the ambient temperature.

For an ambient temperature of 50°C

$$P_{D(max)} = (150^{\circ}\text{C} - 50^{\circ}\text{C}) / 200^{\circ}\text{C/W}$$

$$P_{D(max)} = 500\text{mW}$$

If the intent is to operate from a 4V power source with a 150mA load current from both outputs at a 50°C ambient temperature, the expected power dissipation is found in the following calculation:

$$P_D \text{ (each regulator)} = (V_{IN} - V_{OUT}) * I_{OUT} + (V_{IN} * I_{GND})$$

$$P_D \text{ (each regulator)} = (4V - 3V) * 150\text{mA} + (4V * 0.12\text{mA})$$

$$P_D \text{ (each regulator)} = 150\text{mW}$$

$$P_D \text{ (both regulators)} = 2 * 150\text{mW}$$

$$P_D \text{ (both regulators)} = 300\text{mW}$$

In this example the total power dissipated is 300mW which is below the 500mW maximum package consideration and therefore safe to operate. It should be noted that it is not always possible to operate both regulators at the maximum output current.

Mechanical Dimensions

MSOP-8

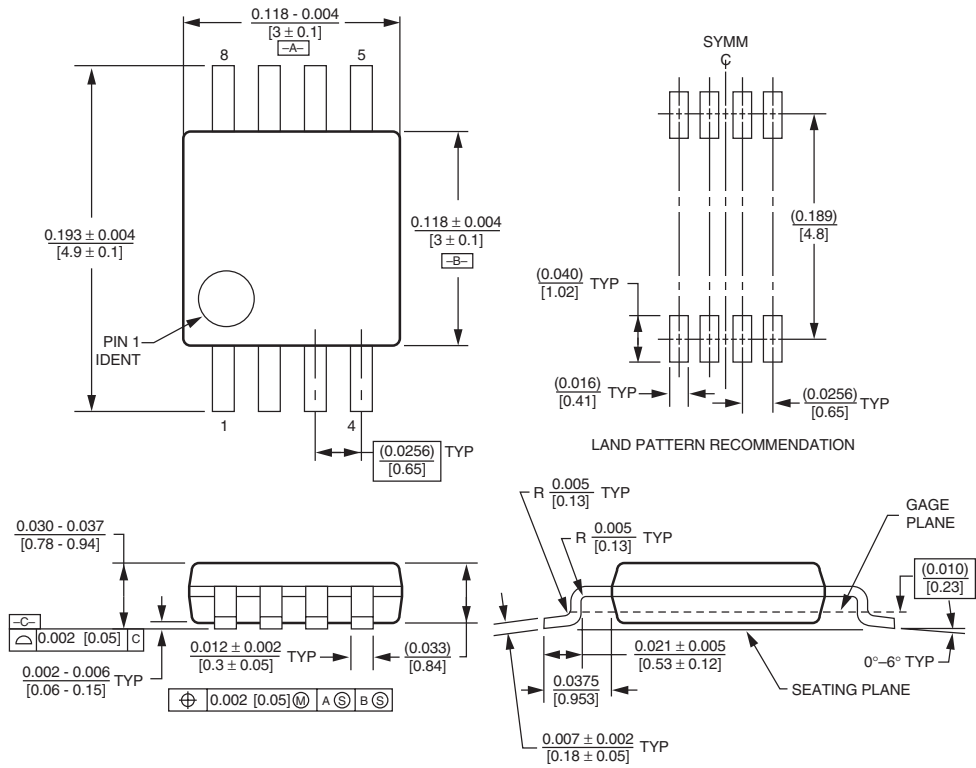

Ordering Information

Part Number	V _{OUT}	Temperature Range (°C)	Package
ILC7280AR2530X	2.5V and 3.0V	-40 to +85	MSOP-8
ILC7280AR2830X	3.0V and 2.8V	-40 to +85	MSOP-8
ILC7280AR2828X	2.8V and 2.8V	-40 to +85	MSOP-8
ILC7280AR8585X	2.85V and 2.85V	-40 to +85	MSOP-8
ILC7280AR3030X	3.0V and 3.0V	-40 to +85	MSOP-8
ILC7280AR3333X	3.3V and 3.3V	-40 to +85	MSOP-8

DISCLAIMER

FAIRCHILD SEMICONDUCTOR RESERVES THE RIGHT TO MAKE CHANGES WITHOUT FURTHER NOTICE TO ANY PRODUCTS HEREIN TO IMPROVE RELIABILITY, FUNCTION OR DESIGN. FAIRCHILD DOES NOT ASSUME ANY LIABILITY ARISING OUT OF THE APPLICATION OR USE OF ANY PRODUCT OR CIRCUIT DESCRIBED HEREIN; NEITHER DOES IT CONVEY ANY LICENSE UNDER ITS PATENT RIGHTS, NOR THE RIGHTS OF OTHERS.

LIFE SUPPORT POLICY

FAIRCHILD'S PRODUCTS ARE NOT AUTHORIZED FOR USE AS CRITICAL COMPONENTS IN LIFE SUPPORT DEVICES OR SYSTEMS WITHOUT THE EXPRESS WRITTEN APPROVAL OF THE PRESIDENT OF FAIRCHILD SEMICONDUCTOR CORPORATION. As used herein:

1. Life support devices or systems are devices or systems which, (a) are intended for surgical implant into the body, or (b) support or sustain life, and (c) whose failure to perform when properly used in accordance with instructions for use provided in the labeling, can be reasonably expected to result in a significant injury of the user.
2. A critical component in any component of a life support device or system whose failure to perform can be reasonably expected to cause the failure of the life support device or system, or to affect its safety or effectiveness.